



Summary

[Request a quote](#)

[Catalog](#)

Number of contacts	5
Wire Size/AWG	30 - 22
Gender	Standard
Socket / Receptacle	Socket / Receptacle - Fixed Panel Front Mounted
Locking system	Threaded
Size	1W
Matching parts	FVG.1W.305.CLAC50
Series	W - Underwater

Technical details

https://www.lemo.com/int_en/solutions/supreme/w-underwater/hvg-1w-305-cllp.html

LEMO products and services are provided "as is". LEMO makes no warranties or representations with regard to LEMO product & services or use of them, express, implied or statutory, including for accuracy, completeness, or security. The user is fully responsible for his products and applications using LEMO components.

Electrical Configuration

Contact Termination Low voltage	Solder
R (max)	4.8 mOhm
Insert configuration value	1W.305 - 5 Low Voltage
Rated current	9 Amps
Vtest (contact-contact)	1250 V (AC) 1800 V (DC)
Vtest (contact-shell)	1150 V (AC) 1600 V (DC)
Contact Type	Solder
Max. Solid Conductor	0.34 mm ² (AWG 22)
Max. Stranded Conductor	0.34 mm ² (AWG 22)
Bucket Dia.	0.8 mm (0.031in)
Contact Dia.	0.9 mm (0.035in)
Number of contacts	5
Wire Size/AWG	30 - 22
Gender	Standard

Form & Material

Shell style / Model id	HV - Fixed socket, nut fixing, vacuumtight
Socket / Receptacle	Fixed Panel Front Mounted
Housing material	Brass (chrome plated [SAE AMS 2460]) shell and collet nut, nickel plated [SAE AMS QQ N 290] brass latch sleeve and mid pieces
Locking system	Threaded
Keying	1 key (alpha=0, Plug: male contacts, Receptacle: female contacts)
Variant	Watertight unmated (connector to device)
Weight	20.27 g

https://www.lemo.com/int_en/solutions/supreme/w-underwater/hvg-1w-305-cllp.html

LEMO products and services are provided "as is". LEMO makes no warranties or representations with regard to LEMO product & services or use of them, express, implied or statutory, including for accuracy, completeness, or security. The user is fully responsible for his products and applications using LEMO components.

Environment

Technical domain	Specialties and Other
Environmental protection (IP rating)	IP68
Minimal temperature	-20°C / +100°C
Climatical Category	20/200/21
Humidity (max)	<=95% [at 60 deg C /140 F]
Shielding (min)	95 dB (10 MHz)
Shielding (min)	80 dB (1 GHz)
Pressure	60 bars
Salt Spray Corrosion	>1000 hr

Drawings

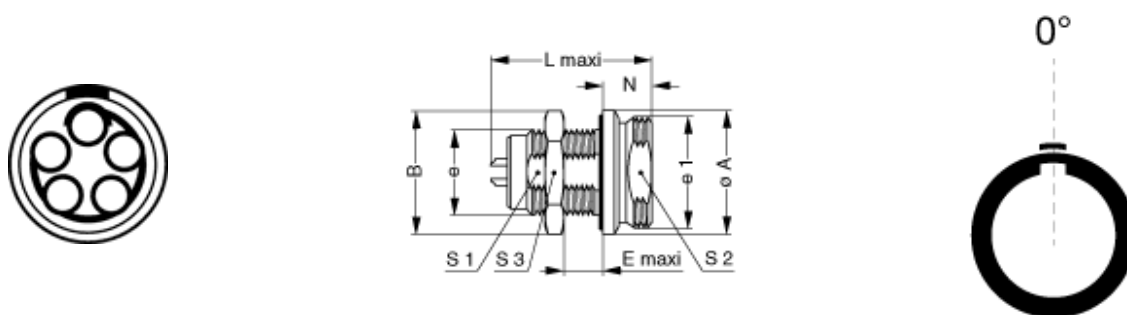

Dimensions

	A	B	e	e1	E	L	N	S1	S2	S3
mm.	18.3	19.5	M14x1.0	M16x1.0	11.5	30	8	12.5	14.5	17
in.	0.72	0.77			0.45	1.18	0.31	0.49	0.57	0.67

Recommended By Lemo









Accessories

Tools

https://www.lemo.com/int_en/solutions/supreme/w-underwater/hvg-1w-305-cllp.html

LEMO products and services are provided "as is". LEMO makes no warranties or representations with regard to LEMO product & services or use of them, express, implied or statutory, including for accuracy, completeness, or security. The user is fully responsible for his products and applications using LEMO components.

Cables

Cable PartNumber	Material	Colour	Cable image
CMN.05.T22.051QGZE	TPR (medical)	Grey	
CMN.05.T28.029PGCE	PVC	GREY	
CMN.05.T28.029PGZE		grey	
CMN.05.T28.029PNCE	PVC	Black	
CMN.05.T28.029PNZE			
150250	PVC	Grey	
50090	PVC	Black	
50140	PVC	Grey	
5050	PVC	Black	

https://www.lemo.com/int_en/solutions/supreme/w-underwater/hvg-1w-305-cllp.html

LEMO products and services are provided "as is". LEMO makes no warranties or representations with regard to LEMO product & services or use of them, express, implied or statutory, including for accuracy, completeness, or security. The user is fully responsible for his products and applications using LEMO components.