



*Image for illustrative purpose only*

## Summary

[Request a quote](#)

[Catalog](#)

Number of contacts Low Voltage	7
Wire Size/AWG	22 - 14
Gender	Standard
Socket / Receptacle	Socket / Receptacle - Fixed Panel Front Mounted
Locking system	Push-pull
Size	4N
Suggested matching part	<a href="#">FMG.4N.307.TLAY11</a>
Series	N - Nuclear Stainless Steel

[https://www.lemo.com/int\\_en/solutions/supreme/n-nuclear-stainless-steel/hsg-4n-307-tllpv.html](https://www.lemo.com/int_en/solutions/supreme/n-nuclear-stainless-steel/hsg-4n-307-tllpv.html)

LEMO products and services are provided "as is". LEMO makes no warranties or representations with regard to LEMO product & services or use of them, express, implied or statutory, including for accuracy, completeness, or security. The user is fully responsible for his products and applications using LEMO components.

# Technical details

## Electrical Configuration

Contact Termination Low voltage	Solder
R (max)	3.3 mOhm
Insert configuration value	4N.307 - 7 Low Voltage
Insulator	L: PEEK (UL 94 / V-0/1.5)
Rated current	20 A
Contact Type	Solder
Max. Solid Conductor	1.5 mm <sup>2</sup> (AWG 14)
Max. Stranded Conductor	1.5 mm <sup>2</sup> (AWG 16)
Bucket Dia.	1.8 mm (0.071in)
Contact Dia.	2 mm (0.079in)
Number of contacts Low Voltage	7
Wire Size/AWG	22 - 14
Gender	Standard

## Form & Material

Shell style / Model id	HSG - Fixed receptacle, with long pre-positioning sleeve, watertight or vaccumtight
Socket / Receptacle	Fixed Panel Front Mounted
Housing material	Stainless steel shell, collet nut and latch sleeve, nickel plated [SAE AMS QQ N 290] brass mid pieces
Locking system	Push-pull
Keying	Push-Pull latch for manipulator. Female contacts
Colour	Grey
Variant	Watertight / Vacuum-tested unmated (connector to device)
Weight	362.92 g

## Environment

Technical domain	Energy and Industrial, Specialties and Other
Environmental sealing (IP rating)	Hermetic unmated
R leak (He) (max)	0.0000001 mbar*l/s (if vacuum-tested)

[https://www.lemo.com/int\\_en/solutions/supreme/n-nuclear-stainless-steel/hsg-4n-307-tllpv.html](https://www.lemo.com/int_en/solutions/supreme/n-nuclear-stainless-steel/hsg-4n-307-tllpv.html)

LEMO products and services are provided "as is". LEMO makes no warranties or representations with regard to LEMO product & services or use of them, express, implied or statutory, including for accuracy, completeness, or security. The user is fully responsible for his products and applications using LEMO components.

# Drawings

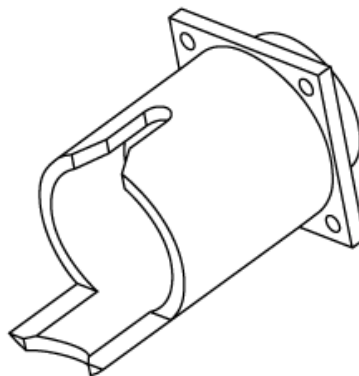
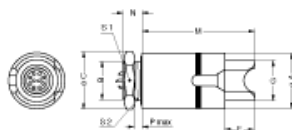















## Dimensions

	<b>A</b>	<b>e</b>	<b>C</b>	<b>F</b>	<b>G</b>	<b>M</b>	<b>N</b>	<b>P</b>	<b>S1</b>	<b>S2</b>
mm.	40	M30x1.0	40.5	20	24	74.0	16.0	9.0	36	28.5
in.	1.57		1.59	0.79	0.94	2.91	0.63	0.35	1.42	1.12

[https://www.lemo.com/int\\_en/solutions/supreme/n-nuclear-stainless-steel/hsg-4n-307-tllpv.html](https://www.lemo.com/int_en/solutions/supreme/n-nuclear-stainless-steel/hsg-4n-307-tllpv.html)

LEMO products and services are provided "as is". LEMO makes no warranties or representations with regard to LEMO product & services or use of them, express, implied or statutory, including for accuracy, completeness, or security. The user is fully responsible for his products and applications using LEMO components.

# Cables

Cable PartNumber	Material	Colour	Cable image
CMN.07.T14.069QGZC	TPR (medical)		
CMN.07.T18.070PGZE		grey	
CMN.07.T18.070PNZE			
CMN.07.T20.062PGZE		grey	
CMN.07.T20.062PNZE			
CMN.07.T20.062QGZE	TPR (medical)	Grey	
CMN.07.T26.037QGZE	TPR (medical)	Grey	
CMN.07.T28.044PGZE		grey	
CMN.07.T28.044PNZE			
270250	PVC	Grey	
370500	PVC	Grey	
70140	PVC	Grey	
7041	PVC	Grey	
7050	PVC	Black	
717920	PVC	Grey	
CTR.75.030.121875G	PVC	Grey	

[https://www.lemo.com/int\\_en/solutions/supreme/n-nuclear-stainless-steel/hsg-4n-307-tllpv.html](https://www.lemo.com/int_en/solutions/supreme/n-nuclear-stainless-steel/hsg-4n-307-tllpv.html)

LEMO products and services are provided "as is". LEMO makes no warranties or representations with regard to LEMO product & services or use of them, express, implied or statutory, including for accuracy, completeness, or security. The user is fully responsible for his products and applications using LEMO components.