



Image for illustrative purpose only

Summary

[Request a quote](#)

[Catalog](#)

Number of contacts Low Voltage	6
Gender	Reverse Gender
Socket / Receptacle	Socket / Receptacle - Fixed Panel Front Mounted
Locking system	Push-pull
Size	3N
Series	N - Nuclear Stainless Steel

https://www.lemo.com/int_en/solutions/supreme/n-nuclear-stainless-steel/hsg-3n-306-tlapv.html

LEMO products and services are provided "as is". LEMO makes no warranties or representations with regard to LEMO product & services or use of them, express, implied or statutory, including for accuracy, completeness, or security. The user is fully responsible for his products and applications using LEMO components.

Technical details

Electrical Configuration

Contact Termination Low voltage	Solder
Insert configuration value	3N.306 - 6 Low Voltage
Insulator	L: PEEK (UL 94 / V-0/1.5)
Rated current	17 A
Contact Type	Solder
Number of contacts Low Voltage	6
Gender	Reverse Gender

Form & Material

Shell style / Model id	HSG - Fixed receptacle, with long pre-positioning sleeve, watertight or vaccumtight
Socket / Receptacle	Fixed Panel Front Mounted
Housing material	Stainless steel shell, collet nut and latch sleeve, nickel plated [SAE AMS QQ N 290] brass mid pieces
Locking system	Push-pull
Keying	Push-Pull latch for manipulator. Male contacts
Colour	Grey
Variant	Watertight / Vacuum-tested unmated (connector to device)
Weight	208.59 g

Environment

Technical domain	Energy and Industrial, Specialties and Other
Environmental sealing (IP rating)	Hermetic unmated
R leak (He) (max)	0.0000001 mbar*/l/s (if vacuum-tested)

Drawings

https://www.lemo.com/int_en/solutions/supreme/n-nuclear-stainless-steel/hsg-3n-306-tlapv.html

LEMO products and services are provided "as is". LEMO makes no warranties or representations with regard to LEMO product & services or use of them, express, implied or statutory, including for accuracy, completeness, or security. The user is fully responsible for his products and applications using LEMO components.

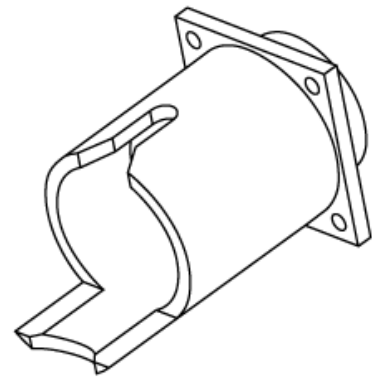
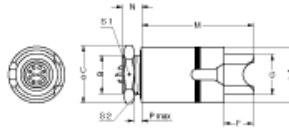

Dimensions

	A	B	C	F	G	M	N	P	S1	S2
mm.	32	M24x1.0	34	18.5	19	68.5	13.0	8.0	30	22.5
in.	1.26		1.34	0.73	0.75	2.7	0.51	0.31	1.18	0.89

https://www.lemo.com/int_en/solutions/supreme/n-nuclear-stainless-steel/hsg-3n-306-tlapv.html

LEMO products and services are provided "as is". LEMO makes no warranties or representations with regard to LEMO product & services or use of them, express, implied or statutory, including for accuracy, completeness, or security. The user is fully responsible for his products and applications using LEMO components.