



Summary

[Request a quote](#)

[Catalog](#)

Number of contacts Low Voltage	6
Wire Size/AWG	34 - 28
Gender	Standard
Socket / Receptacle	Socket / Receptacle - Fixed Panel Rear Mounted
Locking system	Push-pull
Jacket cable outside diameter [mm]	1.00 - 12.60 mm
Size	0K
Suggested matching part	FGG.0K.306.KLAC40
Series	K - Outdoor keyed

https://www.lemo.com/int_en/solutions/originals/k-outdoor-keyed/heg-0k-306-kllp.html

LEMO products and services are provided "as is". LEMO makes no warranties or representations with regard to LEMO product & services or use of them, express, implied or statutory, including for accuracy, completeness, or security. The user is fully responsible for his products and applications using LEMO components.

Technical details

Electrical Configuration

Contact Termination Low voltage	Solder
R (max)	8.7 mOhm
Insert configuration value	0K.306 - 6 Low Voltage
Insulator	L: PEEK (UL 94 / V-0/1.5)
Rated current	2.5 A
Vtest (contact-contact)	850 V (AC), 1200 V (DC)
Vtest (contact-shell)	650 V (AC), 920 V (DC)
Contact Type	Solder
Max. Solid Conductor	0.09 mm ² (AWG 28)
Max. Stranded Conductor	0.09 mm ² (AWG 28)
Bucket Dia.	0.45 mm (0.018in)
Contact Dia.	0.5 mm (0.02in)
Number of contacts Low Voltage	6
Wire Size/AWG	34 - 28
Gender	Standard

Form & Material

Shell style / Model id	HE - Fixed receptacle, nut fixing, watertight or vacuum-tight (back panel mounting)
Socket / Receptacle	Fixed Panel Rear Mounted
Housing material	Brass (black chrome) shell and collet nut, nickel plated [SAE AMS QQ N 290] brass latch sleeve and mid pieces
Locking system	Push-pull
Keying	1 key (alpha=0, plug: male contacts, receptacle: female contacts)
Variant	Watertight unmated (connector to device)
Weight	13 g

https://www.lemo.com/int_en/solutions/originals/k-outdoor-keyed/heg-0k-306-klp.html

LEMO products and services are provided "as is". LEMO makes no warranties or representations with regard to LEMO product & services or use of them, express, implied or statutory, including for accuracy, completeness, or security. The user is fully responsible for his products and applications using LEMO components.

Environment

Technical domain	Audio Video, Energy and Industrial, Medical, Test and Measurement
Environmental sealing (IP rating)	IP68
Endurance	5000 mating cycles
Temperature range	-20°C / +100°C
Climatical Category	20/80/21
Humidity (max)	<=95% [at 60 deg C /140 F]
Shielding (min)	95 dB (10 MHz)
Shielding (min)	80 dB (1 GHz)
Shock Resistance	100 g [6 ms]
Vibration	15 g [10 Hz - 2000 Hz]
Pressure	60 bars
Salt Spray Corrosion	>1000 hr

Cable fixation

Jacket cable outside diameter [mm]	1.00 - 12.60 mm
------------------------------------	-----------------

Drawings

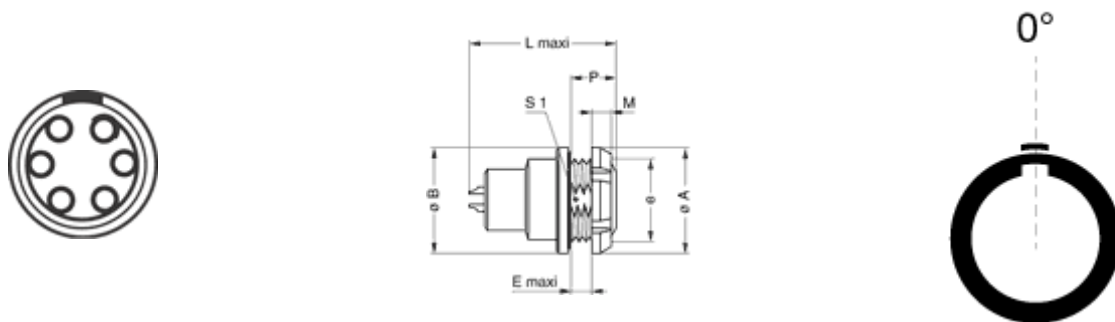

Dimensions

	A	B	L	M	P	S1	e	E
mm.	18	18	22.5	3.5	7	12.5	M14x1.0	2.4
in.	0.71	0.71	0.89	0.14	0.28	0.49		0.09

https://www.lemo.com/int_en/solutions/originals/k-outdoor-keyed/heg-0k-306-klp.html

LEMO products and services are provided "as is". LEMO makes no warranties or representations with regard to LEMO product & services or use of them, express, implied or statutory, including for accuracy, completeness, or security. The user is fully responsible for his products and applications using LEMO components.







Recommended By Lemo

Accessories

Tools

Spanner	DCH.91.181.PA
Spanner wrench	Socket for torque wrench DCM.0E.M14.4

Cables

Cable PartNumber	Material	Colour	Cable image
CMN.06.T28.031PGCE	PVC	GREY	
CMN.06.T28.031PGZE		grey	
CMN.06.T28.031PNCE	PVC	Black	
CMN.06.T28.031PNZE			
CMN.06.T28.042QBCE	TPR (medical)		
CMN.06.T28.044PGZE		grey	
CMN.06.T28.044PNZE			
12080	PVC	Grey	
6280	PVC	Black	

https://www.lemo.com/int_en/solutions/originals/k-outdoor-keyed/heg-0k-306-klp.html

LEMO products and services are provided "as is". LEMO makes no warranties or representations with regard to LEMO product & services or use of them, express, implied or statutory, including for accuracy, completeness, or security. The user is fully responsible for his products and applications using LEMO components.