



Image for illustrative purpose only

Summary

[Request a quote](#)

[Catalog](#)

Number of contacts Low Voltage	3
Wire Size/AWG	34 - 28
Plug	Plug - Straight
Locking system	Threaded
Size	3
Suggested matching part	HRG.03.303.CLLPV

https://www.lemo.com/int_en/fvg-03-303-clak40.html

LEMO products and services are provided "as is". LEMO makes no warranties or representations with regard to LEMO product & services or use of them, express, implied or statutory, including for accuracy, completeness, or security. The user is fully responsible for his products and applications using LEMO components.

Technical details

Electrical Configuration

Contact Termination Low voltage	Solder
R (max)	8.7 mOhm
Insert configuration value	3.303 - 3 Low Voltage
Rated current	3 A
Contact Type	Solder
Max. Solid Conductor	0.09 mm ² (AWG 28)
Max. Stranded Conductor	0.05 mm ² (AWG 30)
Bucket Dia.	0.4 mm (0.016in)
Contact Dia.	0.5 mm (0.02in)
Number of contacts Low Voltage	3
Wire Size/AWG	34 - 28

Form & Material

Shell style / Model id	FVG - Straight plug with oversize cable collet
Plug	Straight
Housing material	Brass (chrome plated [SAE AMS 2460]) shell and collet nut, nickel plated [SAE AMS QQ N 290] brass latch sleeve and mid pieces
Locking system	Threaded
Keying	G: 1 key (alpha=0, Plug: male contacts, Receptacle: female contacts)
Weight	10.67 g

Environment

Environmental sealing (IP rating)	IP68
Temperature range	-20°C / +200°C
Climatical Category	20/200/21
Humidity (max)	<=95% [at 60 deg C /140 F]
Shielding (min)	100 dB (10 MHz)
Shielding (min)	80 dB (1 GHz)
Pressure	60 bars (120 bars with LEMO cable assembly)
Salt Spray Corrosion	>1000 hr

https://www.lemo.com/int_en/fvg-03-303-clak40.html

LEMO products and services are provided "as is". LEMO makes no warranties or representations with regard to LEMO product & services or use of them, express, implied or statutory, including for accuracy, completeness, or security. The user is fully responsible for his products and applications using LEMO components.

Cable fixation

Cable termination protection

Standard back nut (no additional protection)

Fixation type

Cable collet

Drawings

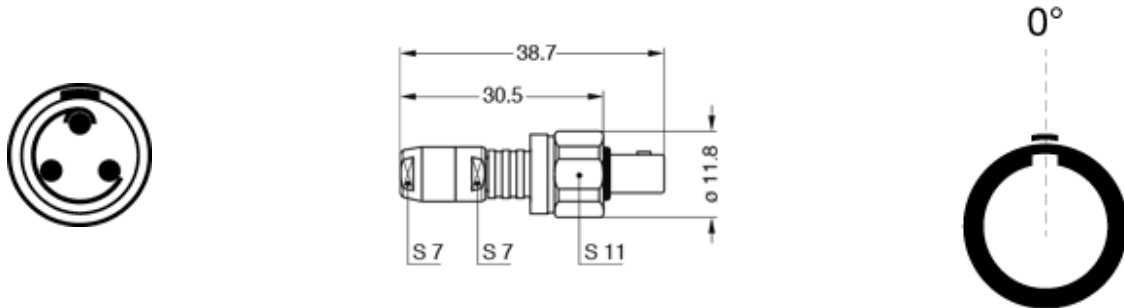

Dimensions

	A	L	M	S1	S2	S3
mm.	11.8	38.7	30.5	11	7	7
in.	0.46	1.52	1.2	0.43	0.28	0.28

https://www.lemo.com/int_en/fvg-03-303-clak40.html

LEMO products and services are provided "as is". LEMO makes no warranties or representations with regard to LEMO product & services or use of them, express, implied or statutory, including for accuracy, completeness, or security. The user is fully responsible for his products and applications using LEMO components.