



Summary

[Request a quote](#)

[Catalog](#)

Number of contacts Low Voltage	8
Wire Size/AWG	30 - 22
Gender	Standard
Plug	Plug - Fixed
Locking system	Snap-on
Size	2K
Suggested matching part	PHG.2K.308.CLLC50
Series	K - Outdoor keyed

https://www.lemo.com/int_en/solutions/originals/k-outdoor-keyed/fag-2k-308-cla.html

LEMO products and services are provided "as is". LEMO makes no warranties or representations with regard to LEMO product & services or use of them, express, implied or statutory, including for accuracy, completeness, or security. The user is fully responsible for his products and applications using LEMO components.

Technical details

Electrical Configuration

Contact Termination Low voltage	Solder
R (max)	4.8 mOhm
Insert configuration value	2K.308 - 8 Low Voltage
Insulator	L: PEEK (UL 94 / V-0/1.5)
Rated current	10 A
Vtest (contact-contact)	1500 V (AC), 2150 V (DC)
Vtest (contact-shell)	1250 V (AC), 1770 V (DC)
Contact Type	Solder
Max. Solid Conductor	0.34 mm ² (AWG 22)
Max. Stranded Conductor	0.34 mm ² (AWG 22)
Bucket Dia.	0.8 mm (0.031in)
Contact Dia.	0.9 mm (0.035in)
Number of contacts Low Voltage	8
Wire Size/AWG	30 - 22
Gender	Standard

Form & Material

Shell style / Model id	FA - Fixed plug, non-latching, nut fixing
Plug	Fixed
Housing material	Brass (chrome plated [SAE AMS 2460]) shell, collet nut and latch sleeve, nickel plated [SAE AMS QQ N 290] brass mid pieces
Locking system	Snap-on
Keying	1 key (alpha=0, plug: male contacts, receptacle: female contacts)
Weight	41.33 g

https://www.lemo.com/int_en/solutions/originals/k-outdoor-keyed/fag-2k-308-cla.html

LEMO products and services are provided "as is". LEMO makes no warranties or representations with regard to LEMO product & services or use of them, express, implied or statutory, including for accuracy, completeness, or security. The user is fully responsible for his products and applications using LEMO components.

Environment

Technical domain	Audio Video, Energy and Industrial, Medical, Test and Measurement
Environmental sealing (IP rating)	IP68
Endurance	5000 mating cycles
Temperature range	-55°C / +200°C
Climatical Category	50/175/21
Humidity (max)	<=95% [at 60 deg C /140 F]
Shielding (min)	95 dB (10 MHz)
Shielding (min)	80 dB (1 GHz)
Shock Resistance	100 g [6 ms]
Vibration	15 g [10 Hz - 2000 Hz]
Salt Spray Corrosion	>1000 hr

Cable fixation

Cable termination protection	Standard back nut (no additional protection)
Fixation type	Cable collet

Drawings

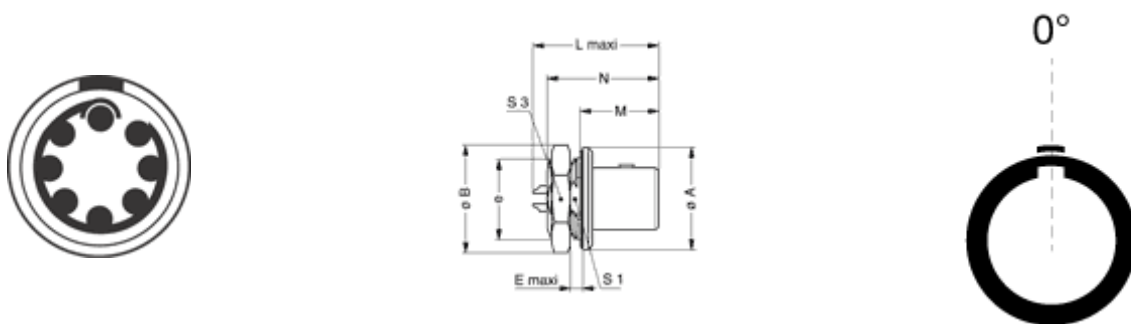

Dimensions

	e	A	B	E	S3	S1	L	M	N
mm.	M20x1.0	25	27.5	4.5	24	18.5	33.6	18	28.3
in.		0.98	1.08	0.18	0.94	0.73	1.32	0.71	1.11

https://www.lemo.com/int_en/solutions/originals/k-outdoor-keyed/fag-2k-308-cla.html













LEMO products and services are provided "as is". LEMO makes no warranties or representations with regard to LEMO product & services or use of them, express, implied or statutory, including for accuracy, completeness, or security. The user is fully responsible for his products and applications using LEMO components.

Recommended By Lemo

Accessories

Tools

Cables

Cable PartNumber	Material	Colour	Cable image
CMN.08.T22.059QGC	TPR	Grey	
CMN.08.T22.059QGZE	TPR (medical)	Grey	
CMN.08.T26.042QGZE	TPR (medical)	Grey	
108220	PVC	Black	
108240	PTFE	White	
108260	PTFE	White	
16080	PVC	Grey	
180240	PVC	Black	
180260	PVC	Black	
280250	PVC	Grey	
335990	PVC	Black	
335991	PVC	Black	
42265	PVC	Yellow	
80140	PVC	Grey	
8050	PVC	Black	
8280	PVC	Black	

https://www.lemo.com/int_en/solutions/originals/k-outdoor-keyed/fag-2k-308-cla.html

LEMO products and services are provided "as is". LEMO makes no warranties or representations with regard to LEMO product & services or use of them, express, implied or statutory, including for accuracy, completeness, or security. The user is fully responsible for his products and applications using LEMO components.