



Summary

[Request a quote](#)

[Catalog](#)

| | |
|--------------------------------|-------------------|
| Number of contacts Low Voltage | 5 |
| Wire Size/AWG | 30 - 22 |
| Gender | Standard |
| Plug | Plug - Fixed |
| Locking system | Snap-on |
| Size | 1K |
| Series | K - Outdoor keyed |

https://www.lemo.com/int_en/solutions/originals/k-outdoor-keyed/fag-1k-305-cla.html

LEMO products and services are provided "as is". LEMO makes no warranties or representations with regard to LEMO product & services or use of them, express, implied or statutory, including for accuracy, completeness, or security. The user is fully responsible for his products and applications using LEMO components.

Technical details

Electrical Configuration

| | |
|---------------------------------|-------------------------------|
| Contact Termination Low voltage | Solder |
| R (max) | 4.8 mOhm |
| Insert configuration value | 1K.305 - 5 Low Voltage |
| Insulator | L: PEEK (UL 94 / V-0/1.5) |
| Rated current | 9 A |
| Vtest (contact-contact) | 1250 V (AC), 1770 V (DC) |
| Vtest (contact-shell) | 1150 V (AC), 1630 V (DC) |
| Contact Type | Solder |
| Max. Solid Conductor | 0.34 mm ² (AWG 22) |
| Max. Stranded Conductor | 0.34 mm ² (AWG 22) |
| Bucket Dia. | 0.8 mm (0.031in) |
| Contact Dia. | 0.9 mm (0.035in) |
| Number of contacts Low Voltage | 5 |
| Wire Size/AWG | 30 - 22 |
| Gender | Standard |

Form & Material

| | |
|------------------------|--|
| Shell style / Model id | FA - Fixed plug, non-latching, nut fixing |
| Plug | Fixed |
| Housing material | Brass (chrome plated [SAE AMS 2460]) shell, collet nut and latch sleeve, nickel plated [SAE AMS QQ N 290] brass mid pieces |
| Locking system | Snap-on |
| Keying | 1 key (alpha=0, plug: male contacts, receptacle: female contacts) |
| Weight | 22.89 g |

https://www.lemo.com/int_en/solutions/originals/k-outdoor-keyed/fag-1k-305-cla.html

LEMO products and services are provided "as is". LEMO makes no warranties or representations with regard to LEMO product & services or use of them, express, implied or statutory, including for accuracy, completeness, or security. The user is fully responsible for his products and applications using LEMO components.

Environment

| | |
|-----------------------------------|---|
| Technical domain | Audio Video, Energy and Industrial, Medical, Test and Measurement |
| Environmental sealing (IP rating) | IP68 |
| Endurance | 5000 mating cycles |
| Temperature range | -55°C / +200°C |
| Climatical Category | 50/175/21 |
| Humidity (max) | <=95% [at 60 deg C /140 F] |
| Shielding (min) | 95 dB (10 MHz) |
| Shielding (min) | 80 dB (1 GHz) |
| Shock Resistance | 100 g [6 ms] |
| Vibration | 15 g [10 Hz - 2000 Hz] |
| Salt Spray Corrosion | >1000 hr |

Cable fixation

| | |
|------------------------------|--|
| Cable termination protection | Standard back nut (no additional protection) |
| Fixation type | Cable collet |

Drawings

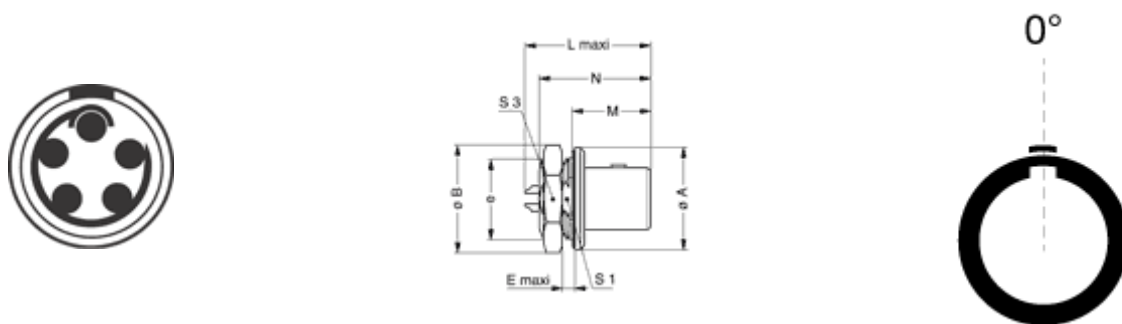

Dimensions

| | A | B | e | E | L | M | N | S1 | S3 |
|-----|----------|----------|----------|----------|----------|----------|----------|-----------|-----------|
| mm. | 20 | 21.5 | M16x1.0 | 2.3 | 22.6 | 16 | 22.5 | 14.5 | 19 |
| in. | 0.79 | 0.85 | | 0.09 | 0.89 | 0.63 | 0.89 | 0.57 | 0.75 |

https://www.lemo.com/int_en/solutions/originals/k-outdoor-keyed/fag-1k-305-cla.html

LEMO products and services are provided "as is". LEMO makes no warranties or representations with regard to LEMO product & services or use of them, express, implied or statutory, including for accuracy, completeness, or security. The user is fully responsible for his products and applications using LEMO components.

Recommended By Lemo









Accessories

Tools

Spanner wrench

[Socket for torque wrench DCM.0E.M14.4](#)

Cables

| Cable PartNumber | Material | Colour | Cable image |
|--------------------|---------------|--------|---|
| CMN.05.T22.051QGZE | TPR (medical) | Grey |  |
| CMN.05.T28.029PGCE | PVC | GREY |  |
| CMN.05.T28.029PGZE | | grey |  |
| CMN.05.T28.029PNCE | PVC | Black |  |
| CMN.05.T28.029PNZE | | |  |
| 150250 | PVC | Grey |  |
| 50090 | PVC | Black |  |
| 50140 | PVC | Grey |  |
| 5050 | PVC | Black |  |

https://www.lemo.com/int_en/solutions/originals/k-outdoor-keyed/fag-1k-305-cla.html

LEMO products and services are provided "as is". LEMO makes no warranties or representations with regard to LEMO product & services or use of them, express, implied or statutory, including for accuracy, completeness, or security. The user is fully responsible for his products and applications using LEMO components.