



Summary

[Request a quote](#)

[Catalog](#)

Number of contacts Low Voltage	4
Wire Size/AWG	24 - 20
Gender	Reverse Gender
Socket / Receptacle	Socket / Receptacle - Fixed Panel Front Mounted
Locking system	Push-pull
Jacket cable outside diameter [mm]	1.00 - 14.60 mm
Size	1K
Suggested matching part	FGL.1K.304.CYMC55
Series	K - Outdoor keyed

https://www.lemo.com/int_en/solutions/originals/k-outdoor-keyed/ehl-1k-304-cyc.html

LEMO products and services are provided "as is". LEMO makes no warranties or representations with regard to LEMO product & services or use of them, express, implied or statutory, including for accuracy, completeness, or security. The user is fully responsible for his products and applications using LEMO components.

Technical details

Electrical Configuration

Contact Termination Low voltage	Crimp
R (max)	4.8 mOhm
Insert configuration value	1K.304 - 4 Low Voltage
Insulator	Y: PEEK for crimp contacts
Rated current	10 A
Vtest (contact-contact)	1700 V (AC), 2400 V (DC)
Vtest (contact-shell)	1800 V (AC), 2550 V (DC)
Contact retention	30 N
Contact Type	Crimp
Max. Conductor	0.5 mm ² (AWG 20)
Min. Conductor	0.25 mm ² (AWG 24)
Bucket Dia.	1.1 mm (0.043in)
Contact Dia.	0.9 mm (0.035in)
Number of contacts Low Voltage	4
Wire Size/AWG	24 - 20
Gender	Reverse Gender

Form & Material

Shell style / Model id	EH - Fixed receptacle, nut fixing and protruding shell
Socket / Receptacle	Fixed Panel Front Mounted
Housing material	Brass (chrome plated [SAE AMS 2460]) shell, collet nut and latch sleeve, nickel plated [SAE AMS QQ N 290] brass mid pieces
Locking system	Push-pull
Keying	2 keys (gamma=75, plug: female contacts, receptacle: male contacts)
Weight	25.52 g

https://www.lemo.com/int_en/solutions/originals/k-outdoor-keyed/ehi-1k-304-cyc.html

LEMO products and services are provided "as is". LEMO makes no warranties or representations with regard to LEMO product & services or use of them, express, implied or statutory, including for accuracy, completeness, or security. The user is fully responsible for his products and applications using LEMO components.

Environment

Technical domain	Audio Video, Energy and Industrial, Medical, Test and Measurement
Environmental sealing (IP rating)	IP68
Endurance	5000 mating cycles
Temperature range	-55°C / +200°C
Climatical Category	50/175/21
Humidity (max)	<=95% [at 60 deg C /140 F]
Shielding (min)	95 dB (10 MHz)
Shielding (min)	80 dB (1 GHz)
Shock Resistance	100 g [6 ms]
Vibration	15 g [10 Hz - 2000 Hz]
Salt Spray Corrosion	>1000 hr

Cable fixation

Jacket cable outside diameter [mm]	1.00 - 14.60 mm
------------------------------------	-----------------

Drawings

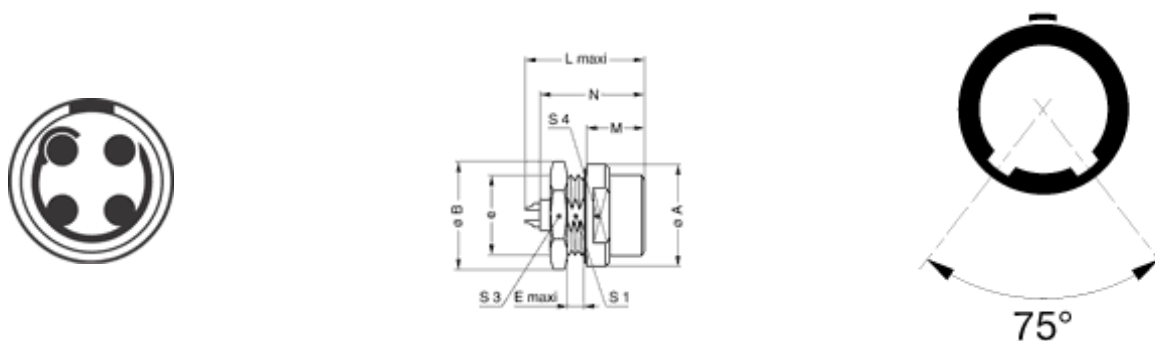

Dimensions

	B	A	S4	S3	S1	N	M	L	E	e
mm.	21.5	20	17	19	14.5	25.1	15.5	27	1.5	M16x1.0
in.	0.85	0.79	0.67	0.75	0.57	0.99	0.61	1.06	0.06	

https://www.lemo.com/int_en/solutions/originals/k-outdoor-keyed/eh1-1k-304-cyc.html

LEMO products and services are provided "as is". LEMO makes no warranties or representations with regard to LEMO product & services or use of them, express, implied or statutory, including for accuracy, completeness, or security. The user is fully responsible for his products and applications using LEMO components.

Recommended By Lemo

Accessories

Replacement contact	FGG.1B.560.ZZC
---------------------	--------------------------------

Tools

Positionner	DCE.91.091.BVC
-------------	--------------------------------















Extraction tool	DCC.09.05B.LAG
-----------------	--------------------------------

Crimp tool	DPC.91.701.V
------------	------------------------------

https://www.lemo.com/int_en/solutions/originals/k-outdoor-keyed/eh1-1k-304-cyc.html

LEMO products and services are provided "as is". LEMO makes no warranties or representations with regard to LEMO product & services or use of them, express, implied or statutory, including for accuracy, completeness, or security. The user is fully responsible for his products and applications using LEMO components.

Cables

Cable PartNumber	Material	Colour	Cable image
CMN.04.T20.053PGZE		grey	
CMN.04.T20.053PNZE			
CMN.04.T20.053QGZE	TPR (medical)	Grey	
CMN.04.T22.047QGC	TPR	Grey	
CMN.04.T22.048QGZE	TPR (medical)	Grey	
CMN.04.T28.031PGCE	PVC	GREY	
CMN.04.T28.031PGZE		grey	
CMN.04.T28.031PNCE	PVC	Black	
CMN.04.T28.031PNZE			
CMN.04.T28.031QGC	TPR	Grey	
140240	PVC	Black	
140250	PVC	Grey	
240500	PVC	Grey	
240750	PVC	Grey	
40080	PVC	Black	
40086	PVC	Blue	
40140	PVC	Black	
40240	PTFE	White	
40260	PVC	Black	
4041	PVC	Grey	
4050	PVC	Black	
4080	PVC	Grey	
417920	PVC	Grey	
4220	PVC	Black	
4221	PVC	Black	
4260	PTFE	White	
4280	PVC	Black	
80080	PVC	Grey	
80082	PVC	Red	
80084	PVC	Black	
CTR.75.030.121870G	PVC	Grey	

https://www.lemo.com/int_en/solutions/originals/k-outdoor-keyed/eh1-1k-304-cyc.html

LEMO products and services are provided "as is". LEMO makes no warranties or representations with regard to LEMO product & services or use of them, express, implied or statutory, including for accuracy, completeness, or security. The user is fully responsible for his products and applications using LEMO components.