



Summary

[Request a quote](#)

[Catalog](#)

Number of contacts Low Voltage	7
Wire Size/AWG	28 - 20
Gender	Standard
Socket / Receptacle	Socket / Receptacle - Fixed Panel Front Mounted
Locking system	Push-pull
Jacket cable outside diameter [mm]	1.00 - 18.60 mm
Size	2K
Suggested matching part	FGG.2K.307.CLAC85
Series	K - Outdoor keyed

https://www.lemo.com/int_en/solutions/originals/k-outdoor-keyed/ehg-2k-307-cll.html

LEMO products and services are provided "as is". LEMO makes no warranties or representations with regard to LEMO product & services or use of them, express, implied or statutory, including for accuracy, completeness, or security. The user is fully responsible for his products and applications using LEMO components.

Technical details

Electrical Configuration

Contact Termination Low voltage	Solder
R (max)	3.6 mOhm
Insert configuration value	2K.307 - 7 Low Voltage
Insulator	L: PEEK (UL 94 / V-0/1.5)
Rated current	11 A
Vtest (contact-contact)	1750 V (AC), 2500 V (DC)
Vtest (contact-shell)	1600 V (AC), 2250 V (DC)
Contact Type	Solder
Max. Solid Conductor	0.5 mm ² (AWG 20)
Max. Stranded Conductor	0.5 mm ² (AWG 20)
Bucket Dia.	1 mm (0.039in)
Contact Dia.	1.3 mm (0.051in)
Number of contacts Low Voltage	7
Wire Size/AWG	28 - 20
Gender	Standard

Form & Material

Shell style / Model id	EH - Fixed receptacle, nut fixing and protruding shell
Socket / Receptacle	Fixed Panel Front Mounted
Housing material	Brass (chrome plated [SAE AMS 2460]) shell, collet nut and latch sleeve, nickel plated [SAE AMS QQ N 290] brass mid pieces
Locking system	Push-pull
Keying	1 key (alpha=0, plug: male contacts, receptacle: female contacts)
Weight	40.97 g

https://www.lemo.com/int_en/solutions/originals/k-outdoor-keyed/ehg-2k-307-cll.html

LEMO products and services are provided "as is". LEMO makes no warranties or representations with regard to LEMO product & services or use of them, express, implied or statutory, including for accuracy, completeness, or security. The user is fully responsible for his products and applications using LEMO components.

Environment

Technical domain	Audio Video, Energy and Industrial, Medical, Test and Measurement
Environmental sealing (IP rating)	IP68
Endurance	5000 mating cycles
Temperature range	-55°C / +200°C
Climatical Category	50/175/21
Humidity (max)	<=95% [at 60 deg C /140 F]
Shielding (min)	95 dB (10 MHz)
Shielding (min)	80 dB (1 GHz)
Shock Resistance	100 g [6 ms]
Vibration	15 g [10 Hz - 2000 Hz]
Salt Spray Corrosion	>1000 hr

Cable fixation

Jacket cable outside diameter [mm]	1.00 - 18.60 mm
------------------------------------	-----------------

Drawings

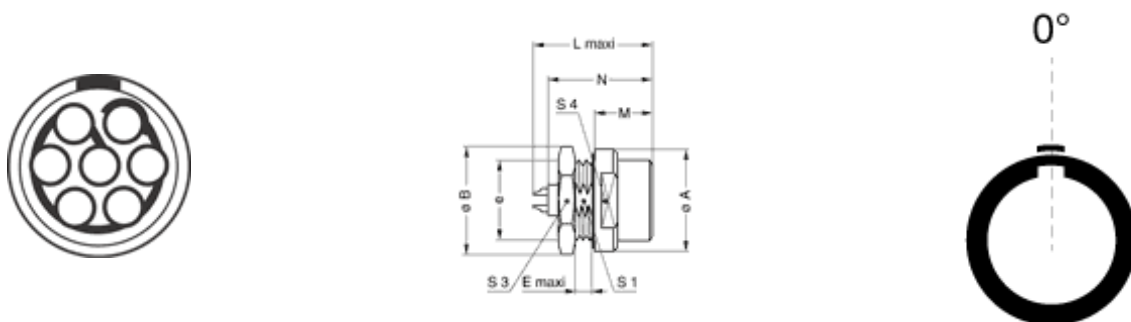

Dimensions

	e	A	B	N	E	L	M	S1	S4	S3
mm.	M20x1.0	25	27.5	27.1	1.5	30.7	17	18.5	20	24
in.		0.98	1.08	1.07	0.06	1.21	0.67	0.73	0.79	0.94

https://www.lemo.com/int_en/solutions/originals/k-outdoor-keyed/ehg-2k-307-cll.html













LEMO products and services are provided "as is". LEMO makes no warranties or representations with regard to LEMO product & services or use of them, express, implied or statutory, including for accuracy, completeness, or security. The user is fully responsible for his products and applications using LEMO components.

Recommended By Lemo

Accessories

Tools

Cables

Cable PartNumber	Material	Colour	Cable image
CMN.07.T20.062PGZE		grey	
CMN.07.T20.062PNZE			
CMN.07.T20.062QGZE	TPR (medical)	Grey	
CMN.07.T26.037QGZE	TPR (medical)	Grey	
CMN.07.T28.044PGZE		grey	
CMN.07.T28.044PNZE			
270250	PVC	Grey	
370500	PVC	Grey	
70140	PVC	Grey	
7041	PVC	Grey	
7050	PVC	Black	
717920	PVC	Grey	
CTR.75.030.121875G	PVC	Grey	

https://www.lemo.com/int_en/solutions/originals/k-outdoor-keyed/ehg-2k-307-cll.html

LEMO products and services are provided "as is". LEMO makes no warranties or representations with regard to LEMO product & services or use of them, express, implied or statutory, including for accuracy, completeness, or security. The user is fully responsible for his products and applications using LEMO components.