



Summary

[Request a quote](#)

[Catalog](#)

Number of contacts Low Voltage	10
Wire Size/AWG	24 - 16
Gender	Standard
Socket / Receptacle	Socket / Receptacle - Fixed Panel Front Mounted
Locking system	Push-pull
Jacket cable outside diameter [mm]	4.00 - 28.60 mm
Size	4K
Suggested matching part	FGG.4K.310.TLAC11E
Series	K - Outdoor keyed

https://www.lemo.com/int_en/solutions/originals/k-outdoor-keyed/egg-4k-310-tlle.html

LEMO products and services are provided "as is". LEMO makes no warranties or representations with regard to LEMO product & services or use of them, express, implied or statutory, including for accuracy, completeness, or security. The user is fully responsible for his products and applications using LEMO components.

Technical details

Electrical Configuration

Contact Termination Low voltage	Solder
R (max)	3.5 mOhm
Insert configuration value	4K.310 - 10 Low Voltage
Insulator	L: PEEK (UL 94 / V-0/1.5)
Rated current	17 A
Vtest (contact-contact)	1850 V (AC), 2600 V (DC)
Vtest (contact-shell)	1300 V (AC), 1840 V (DC)
Contact Type	Solder
Max. Solid Conductor	1 mm ² (AWG 16)
Max. Stranded Conductor	1 mm ² (AWG 18)
Bucket Dia.	1.4 mm (0.055in)
Contact Dia.	1.6 mm (0.063in)
Number of contacts Low Voltage	10
Wire Size/AWG	24 - 16
Gender	Standard

Form & Material

Shell style / Model id	EG - Fixed receptacle, nut fixing, gasket and O-ring in EPDM
Socket / Receptacle	Fixed Panel Front Mounted
Housing material	Stainless steel shell, collet nut and latch sleeve, nickel plated [SAE AMS QQ N 290] brass mid pieces
Locking system	Push-pull
Keying	1 key (alpha=0, plug: male contacts, receptacle: female contacts)
Variant	Gasket and O-ring in EPDM
Weight	104.63 g

https://www.lemo.com/int_en/solutions/originals/k-outdoor-keyed/egg-4k-310-tlle.html

LEMO products and services are provided "as is". LEMO makes no warranties or representations with regard to LEMO product & services or use of them, express, implied or statutory, including for accuracy, completeness, or security. The user is fully responsible for his products and applications using LEMO components.

Environment

Technical domain	Audio Video, Energy and Industrial, Medical, Test and Measurement
Environmental sealing (IP rating)	IP68
Endurance	5000 mating cycles
Temperature range	-55°C / +200°C
Climatical Category	50/175/21
Humidity (max)	<=95% [at 60 deg C /140 F]
Shielding (min)	95 dB (10 MHz)
Shielding (min)	80 dB (1 GHz)
Shock Resistance	100 g [6 ms]
Vibration	15 g [10 Hz - 2000 Hz]

Cable fixation

Jacket cable outside diameter [mm]	4.00 - 28.60 mm
------------------------------------	-----------------

Drawings

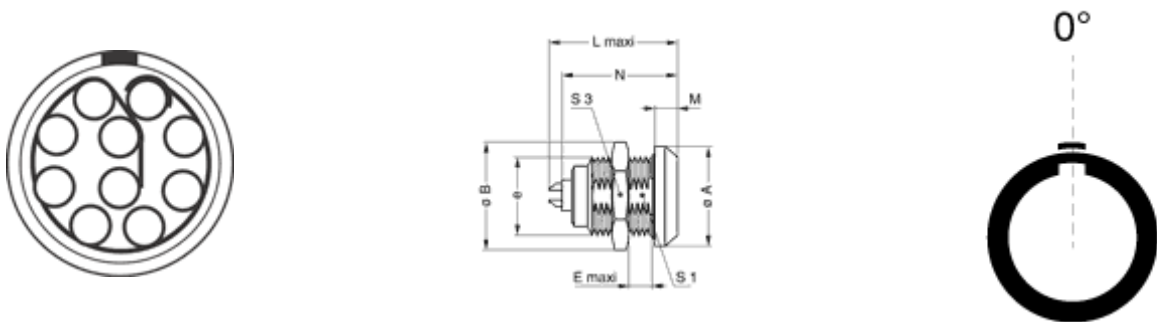

Dimensions

	B	E	L	M	N	S1	S3	A	e
mm.	41.5	9	40.2	6.5	38.6	28.5	36	37	M30x1.0
in.	1.63	0.35	1.58	0.26	1.52	1.12	1.42	1.46	

https://www.lemo.com/int_en/solutions/originals/k-outdoor-keyed/egg-4k-310-tle.html













LEMO products and services are provided "as is". LEMO makes no warranties or representations with regard to LEMO product & services or use of them, express, implied or statutory, including for accuracy, completeness, or security. The user is fully responsible for his products and applications using LEMO components.

Recommended By Lemo

Accessories

Tools

Cables

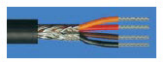
Cable PartNumber	Material	Colour	Cable image
CMN.10.T20.080PGZE		grey	
CMN.10.T20.080PNZE			
CMN.10.T20.080QGC	TPR	Grey	
CMN.10.T22.068QGZE	TPR (medical)	Grey	
CMN.10.T28.052PGZE		grey	
CMN.10.T28.052PNZE			
CMN.10.T28.053QGZE	TPR (medical)	Grey	
110220	PVC	Black	
110240	PTFE	White	
110260	PTFE	White	
110280	PVC	Black	
210140	PVC	Grey	
210240	PVC	Black	
210250	PVC	Grey	
210260	PVC	Black	

https://www.lemo.com/int_en/solutions/originals/k-outdoor-keyed/egg-4k-310-tle.html

LEMO products and services are provided "as is". LEMO makes no warranties or representations with regard to LEMO product & services or use of them, express, implied or statutory, including for accuracy, completeness, or security. The user is fully responsible for his products and applications using LEMO components.