



Image for illustrative purpose only

Summary

[Request a quote](#)

[Catalog](#)

Number of contacts Low Voltage	10
Wire Size/AWG	18 - 10
Socket / Receptacle	Socket / Receptacle - Fixed Panel Front Mounted
Locking system	Push-pull
Size	5N
Suggested matching part	FMG.5N.310.TLAY13
Series	N - Nuclear Stainless Steel

https://www.lemo.com/int_en/solutions/supreme/n-nuclear-stainless-steel/edg-5n-310-tll.html

LEMO products and services are provided "as is". LEMO makes no warranties or representations with regard to LEMO product & services or use of them, express, implied or statutory, including for accuracy, completeness, or security. The user is fully responsible for his products and applications using LEMO components.

Technical details

Electrical Configuration

Contact Termination Low voltage	Solder
R (max)	3.1 mOhm
Insert configuration value	5N.310 - 10 Low Voltage
Insulator	L: PEEK (UL 94 / V-0/1.5)
Rated current	20 A
Contact Type	Solder
Max. Solid Conductor	4 mm ² (AWG 10)
Max. Stranded Conductor	4 mm ² (AWG 12)
Bucket Dia.	2.7 mm (0.106in)
Contact Dia.	3 mm (0.118in)
Number of contacts Low Voltage	10
Wire Size/AWG	18 - 10

Form & Material

Shell style / Model id	EDG - Fixed receptacle with square flange, 4 screw fixing, with long pre-positioning sleeve
Socket / Receptacle	Fixed Panel Front Mounted
Housing material	Stainless steel shell, collet nut and latch sleeve, nickel plated [SAE AMS QQ N 290] brass mid pieces
Locking system	Push-pull
Keying	Push-Pull latch for manipulator. Female contacts
Colour	Grey
Weight	707.75 g

Environment

Technical domain	Energy and Industrial, Specialties and Other
Environmental sealing (IP rating)	IP66

Drawings

https://www.lemo.com/int_en/solutions/supreme/n-nuclear-stainless-steel/edg-5n-310-tll.html

LEMO products and services are provided "as is". LEMO makes no warranties or representations with regard to LEMO product & services or use of them, express, implied or statutory, including for accuracy, completeness, or security. The user is fully responsible for his products and applications using LEMO components.

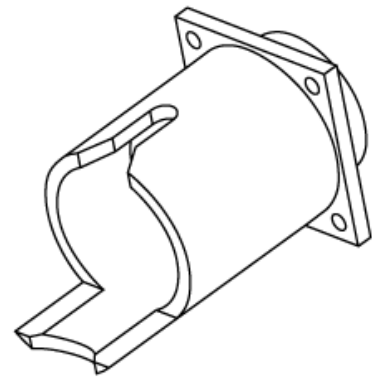
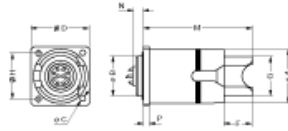
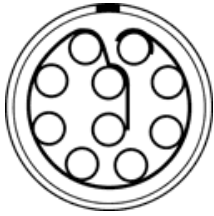















Dimensions

	A	B	C	D	F	G	H	M	N	P
mm.	55	45	5.2	58	28.0	35	46	94.0	13.2	5
in.	2.17	1.77	0.2	2.28	1.1	1.38	1.81	3.7	0.52	0.2

https://www.lemo.com/int_en/solutions/supreme/n-nuclear-stainless-steel/edg-5n-310-tll.html

LEMO products and services are provided "as is". LEMO makes no warranties or representations with regard to LEMO product & services or use of them, express, implied or statutory, including for accuracy, completeness, or security. The user is fully responsible for his products and applications using LEMO components.

Cables

Cable PartNumber	Material	Colour	Cable image
CMN.10.T20.080PGZE		grey	
CMN.10.T20.080PNZE			
CMN.10.T20.080QGC	TPR	Grey	
CMN.10.T22.068QGZE	TPR (medical)	Grey	
CMN.10.T28.052PGZE		grey	
CMN.10.T28.052PNZE			
CMN.10.T28.053QGZE	TPR (medical)	Grey	
110220	PVC	Black	
110240	PTFE	White	
110260	PTFE	White	
110280	PVC	Black	
210140	PVC	Grey	
210240	PVC	Black	
210250	PVC	Grey	
210260	PVC	Black	

https://www.lemo.com/int_en/solutions/supreme/n-nuclear-stainless-steel/edg-5n-310-tll.html

LEMO products and services are provided "as is". LEMO makes no warranties or representations with regard to LEMO product & services or use of them, express, implied or statutory, including for accuracy, completeness, or security. The user is fully responsible for his products and applications using LEMO components.