



*Image for illustrative purpose only*

## Summary

[Request a quote](#)

[Catalog](#)

Number of contacts Low Voltage	24
Wire Size/AWG	24 - 20
Socket / Receptacle	Socket / Receptacle - Fixed Panel Front Mounted
Locking system	Push-pull
Size	4N
Series	N - Nuclear Stainless Steel

[https://www.lemo.com/int\\_en/solutions/supreme/n-nuclear-stainless-steel/edg-4n-324-tym.html](https://www.lemo.com/int_en/solutions/supreme/n-nuclear-stainless-steel/edg-4n-324-tym.html)

LEMO products and services are provided "as is". LEMO makes no warranties or representations with regard to LEMO product & services or use of them, express, implied or statutory, including for accuracy, completeness, or security. The user is fully responsible for his products and applications using LEMO components.

# Technical details

## Electrical Configuration

Contact Termination Low voltage	Crimp
R (max)	4.8 mOhm
Insert configuration value	4N.324 - 24 Low Voltage
Insulator	Y: PEEK
Rated current	7 A
Contact retention	30 N
Contact Type	Crimp
Max. Conductor	0.5 mm <sup>2</sup> (AWG 20)
Min. Conductor	0.25 mm <sup>2</sup> (AWG 24)
Bucket Dia.	1.1 mm (0.043in)
Contact Dia.	0.9 mm (0.035in)
Number of contacts Low Voltage	24
Wire Size/AWG	24 - 20

## Form & Material

Shell style / Model id	EDG - Fixed receptacle with square flange, 4 screw fixing, with long pre-positioning sleeve
Socket / Receptacle	Fixed Panel Front Mounted
Housing material	Stainless steel shell, collet nut and latch sleeve, nickel plated [SAE AMS QQ N 290] brass mid pieces
Locking system	Push-pull
Keying	Push-Pull latch for manipulator. Female contacts
Colour	Grey

## Environment

Technical domain	Energy and Industrial, Specialties and Other
Environmental sealing (IP rating)	IP66

# Drawings

[https://www.lemo.com/int\\_en/solutions/supreme/n-nuclear-stainless-steel/edg-4n-324-tym.html](https://www.lemo.com/int_en/solutions/supreme/n-nuclear-stainless-steel/edg-4n-324-tym.html)

LEMO products and services are provided "as is". LEMO makes no warranties or representations with regard to LEMO product & services or use of them, express, implied or statutory, including for accuracy, completeness, or security. The user is fully responsible for his products and applications using LEMO components.

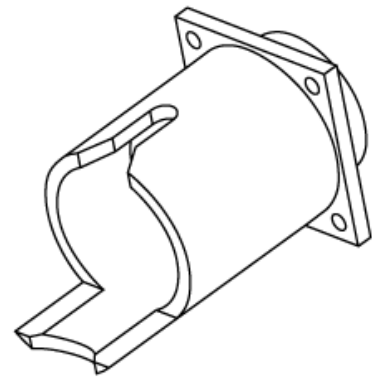
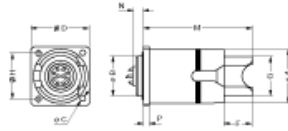

## Dimensions

	A	B	C	D	F	G	H	M	N	P
mm.	40	30	4.2	43	20.0	24	35	74.0	10.7	4
in.	1.57	1.18	0.17	1.69	0.79	0.94	1.38	2.91	0.42	0.16

## Recommended By Lemo

### Accessories

Replacement contact

[EGG.4B.660.ZZM](#)

### Tools









Extraction tool

[DCC.09.05B.LAG](#)

[https://www.lemo.com/int\\_en/solutions/supreme/n-nuclear-stainless-steel/edg-4n-324-tym.html](https://www.lemo.com/int_en/solutions/supreme/n-nuclear-stainless-steel/edg-4n-324-tym.html)

LEMO products and services are provided "as is". LEMO makes no warranties or representations with regard to LEMO product & services or use of them, express, implied or statutory, including for accuracy, completeness, or security. The user is fully responsible for his products and applications using LEMO components.

# Cables

Cable PartNumber	Material	Colour	Cable image
CMN.24.T22.082PGCE	PVC	GREY	
CMN.24.T22.082PGZE		grey	
CMN.24.T22.082PNCE	PVC	Black	
CMN.24.T22.082PNZE			
224260	PVC	Black	
248080	PVC	Grey	
324220	PVC	Black	
324240	PVC	Black	
424250	PVC	Grey	
524500	PVC	Grey	
524750	PVC	Grey	

[https://www.lemo.com/int\\_en/solutions/supreme/n-nuclear-stainless-steel/edg-4n-324-tym.html](https://www.lemo.com/int_en/solutions/supreme/n-nuclear-stainless-steel/edg-4n-324-tym.html)

LEMO products and services are provided "as is". LEMO makes no warranties or representations with regard to LEMO product & services or use of them, express, implied or statutory, including for accuracy, completeness, or security. The user is fully responsible for his products and applications using LEMO components.