



*Image for illustrative purpose only*

## Summary

[Request a quote](#)

[Catalog](#)

Number of contacts Low Voltage	2
Wire Size/AWG	20 - 16
Gender	Standard
Socket / Receptacle	Socket / Receptacle - Fixed Panel Front Mounted
Locking system	Ratchet
Jacket cable outside diameter [mm]	4.85 - 9.70 mm
Size	1M
Suggested matching part	<a href="#">FMN.1M.302.XLC</a>
Series	M - Rugged Ratchet coupling

[https://www.lemo.com/int\\_en/solutions/optima/m-ratchet-coupling/ecn-1m-302-xlm.html](https://www.lemo.com/int_en/solutions/optima/m-ratchet-coupling/ecn-1m-302-xlm.html)

LEMO products and services are provided "as is". LEMO makes no warranties or representations with regard to LEMO product & services or use of them, express, implied or statutory, including for accuracy, completeness, or security. The user is fully responsible for his products and applications using LEMO components.

# Technical details

## Electrical Configuration

Contact Termination Low voltage	Crimp
R (max)	3.6 mOhm
Insert configuration value	1M.302 - 2 Low Voltage
Insulator	L: PEEK
Rated current	19 A
Contact retention	40 N
Contact Type	Crimp
Max. Conductor	1 mm <sup>2</sup> (AWG 18)
Min. Conductor	0.5 mm <sup>2</sup> (AWG 20)
Bucket Dia.	1.4 mm (0.055in)
Contact Dia.	1.3 mm (0.051in)
Number of contacts Low Voltage	2
Wire Size/AWG	20 - 16
Gender	Standard

## Form & Material

Shell style / Model id	EC - Fixed receptacle with two nuts
Socket / Receptacle	Fixed Panel Front Mounted
Housing material	Aluminium (nickel plated [SAE AMS QQ N 290], anthracite color) shell and nut, other pieces bronze/brass
Locking system	Ratchet
Keying	N: 3 keys (beta=165, gamma=30, plug: male contacts, receptacle: female contacts)
Colour	Grey
Weight	58.25 g

[https://www.lemo.com/int\\_en/solutions/optima/m-ratchet-coupling/ecn-1m-302-xlm.html](https://www.lemo.com/int_en/solutions/optima/m-ratchet-coupling/ecn-1m-302-xlm.html)

LEMO products and services are provided "as is". LEMO makes no warranties or representations with regard to LEMO product & services or use of them, express, implied or statutory, including for accuracy, completeness, or security. The user is fully responsible for his products and applications using LEMO components.

## Environment

Technical domain	Motorsport, Security and Defence, Transportation, Aerospace and UAV
Environmental sealing (IP rating)	IP50
Endurance	3000 mating cycles
Temperature range	-20°C / +200°C
EMI Shielding EIA 364-66A	>= 80 dB (1 GHz), >=70 dB (3 GHz), >= 58 dB (6 GHz), >= 40 dB (10 GHz)
Gunfire vibration	25 Hz - 2000 Hz, 3 axis (Apache helicopter)
Humidity (max)	21 days at 95%
Lighting strike EIA 364-76	10K amps - 6 times
Shock Resistance	300 g [ 3 ms]
Thermal shock	5 cycles: -65°C to +150°C
Vibration-Random	37.8 g rms - 3 axes, 4 hr amb [50 Hz - 2000 Hz]
Vibration-Sine	30 g, 3 axes, 12 hr [10 Hz - 2000 Hz]
Salt Spray Corrosion	max. 48 hr

## Cable fixation

Jacket cable outside diameter [mm]	4.85 - 9.70 mm
------------------------------------	----------------

## Drawings

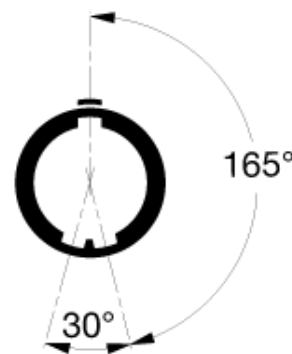
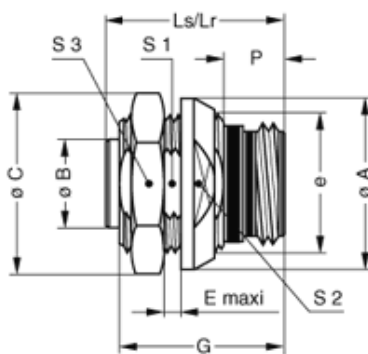
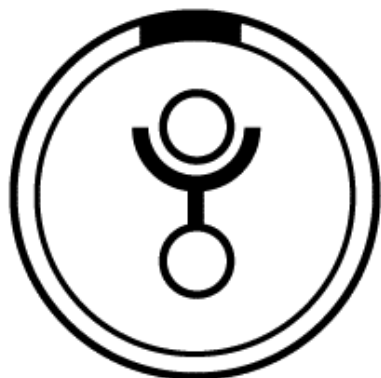

## Dimensions

	A	B	C	E	e	G	Ls	Lr	P	S1	S2	S3
mm.	18	5.95	19.2	5	M14x1.00	16.8	18.3	18.3	5.3	12.5	16	17
in.	0.71	0.23	0.76	0.2		0.66	0.72	0.72	0.21	0.49	0.63	0.67

[https://www.lemo.com/int\\_en/solutions/optima/m-ratchet-coupling/ecn-1m-302-xlm.html](https://www.lemo.com/int_en/solutions/optima/m-ratchet-coupling/ecn-1m-302-xlm.html)

LEMO products and services are provided "as is". LEMO makes no warranties or representations with regard to LEMO product & services or use of them, express, implied or statutory, including for accuracy, completeness, or security. The user is fully responsible for his products and applications using LEMO components.

# Recommended By Lemo

## Accessories

---

Replacement contact [EGN.0M.665.ZZM](#)

---

Compatible cap [BGK.1M.200.XAZ](#)

## Tools

---

Positionner [DCE.91.130.5MVM](#)

---

Extraction tool [DCF.93.131.4LT](#)

---

Crimp tool [DPC.91.701.V](#)





















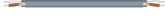













---

Spanner wrench [DCM.65.160.AZ](#)

[https://www.lemo.com/int\\_en/solutions/optima/m-ratchet-coupling/ecn-1m-302-xlm.html](https://www.lemo.com/int_en/solutions/optima/m-ratchet-coupling/ecn-1m-302-xlm.html)

LEMO products and services are provided "as is". LEMO makes no warranties or representations with regard to LEMO product & services or use of them, express, implied or statutory, including for accuracy, completeness, or security. The user is fully responsible for his products and applications using LEMO components.

# Cables

Cable PartNumber	Material	Colour	Cable image
CMN.02.T18.064UNCU			
CMN.02.T20.047PGZE		grey	
CMN.02.T20.047PNZE			
CMN.02.T20.048QGZE	TPR (medical)	Grey	
CMN.02.T28.030PGCE	PVC	GREY	
CMN.02.T28.030PGZE		grey	
CMN.02.T28.030PNCE	PVC	Black	
CMN.02.T28.030PNZE			
102080	PVC	Grey	
120184	PVC	Black	
120240	PVC	Black	
120250	PVC	Grey	
120500	PVC	Grey	
120501	PVC	Grey	
120751	PVC	Grey	
20140	PVC	Grey	
20140	PVC	Grey	
20141	PVC	Grey	
20142	PVC	Red	
20143	PVC	Green	
20144	PVC	Black	
20145	PVC	Yellow	
20146	PVC	Black	
20240	PTFE	White	
20260	PVC	Black	
20264	PVC	Black	
20266	PVC	Violet	
2050	PVC	Black	
20550	PUR	Black	
20560	PUR	White	
2080	PVC	Grey	
220151	PVC	Grey	
220750	PVC	Grey	
2221	PVC	Black	
2260	PTFE	White	
2280	PVC	Black	
320150	PVC	Grey	
4082	PVC	Grey	
CMB.02.210.635	PUR	Black	

[https://www.lemo.com/int\\_en/solutions/optima/m-ratchet-coupling/ecn-1m-302-xlm.html](https://www.lemo.com/int_en/solutions/optima/m-ratchet-coupling/ecn-1m-302-xlm.html)

LEMO products and services are provided "as is". LEMO makes no warranties or representations with regard to LEMO product & services or use of them, express, implied or statutory, including for accuracy, completeness, or security. The user is fully responsible for his products and applications using LEMO components.