



Image for illustrative purpose only

Summary

[Request a quote](#)

[Catalog](#)

Number of contacts Low Voltage	7
Wire Size/AWG	24 - 16
Gender	Standard
Socket / Receptacle	Socket / Receptacle - Fixed Panel Rear Mounted
Locking system	Push-pull
Jacket cable outside diameter [mm]	2.00 - 16.60 mm
Size	3B
Suggested matching part	FGG.3B.307.CLAD10
Series	B - Indoor keyed

https://www.lemo.com/int_en/solutions/originals/b-indoor-keyed/ecg-3b-307-cll.html

LEMO products and services are provided "as is". LEMO makes no warranties or representations with regard to LEMO product & services or use of them, express, implied or statutory, including for accuracy, completeness, or security. The user is fully responsible for his products and applications using LEMO components.

Technical details

Electrical Configuration

Number of contacts Low Voltage	7
Contact Termination Low voltage	Solder
R (max)	3.5 mOhm
Insert configuration value	3B.307 - 7 Low Voltage
Insulator	L: PEEK (UL 94 / V-0/1.5)
Rated current	11 A
Vtest (contact-contact)	2.4 kV (DC)
Vtest (contact-shell)	1.8 kV (DC)
Max. Solid Conductor	1 mm ² (AWG 16)
Max. Stranded Conductor	1 mm ² (AWG 18)
Bucket Dia.	1.4 mm (0.055in)
Contact Dia.	1.6 mm (0.063in)
Wire Size/AWG	24 - 16
Gender	Standard

Form & Material

Shell style / Model id	EC - Fixed receptacle with two nuts (back panel mounting)
Socket / Receptacle	Fixed Panel Rear Mounted
Housing material	Brass (chrome plated [SAE AMS 2460]) shell and collet nut, nickel plated [SAE AMS QQ N 290] brass latch sleeve and mid pieces
Locking system	Push-pull
Keying	G: 1 key (alpha=0, plug: male contacts, receptacle: female contacts)
Colour	Grey
Weight	30.91 g

https://www.lemo.com/int_en/solutions/originals/b-indoor-keyed/ecg-3b-307-cll.html

LEMO products and services are provided "as is". LEMO makes no warranties or representations with regard to LEMO product & services or use of them, express, implied or statutory, including for accuracy, completeness, or security. The user is fully responsible for his products and applications using LEMO components.

Environment

Technical domain	Audio Video, Energy and Industrial, Medical, Semiconductor, Specialties and Other, Test and Measurement, Transportation, Aerospace and UAV
Environmental sealing (IP rating)	IP50
Endurance	5000 mating cycles
Temperature range	-55°C / +250°C (max. temperature valid for short periods of use.)
Climatical Category	50/175/21
Humidity (max)	<=95% [at 60 deg C /140 F]
Shielding (min)	75 dB (10 MHz)
Shielding (min)	40 dB (1 GHz)
Shock Resistance	100 g [6 ms]
Vibration	15 g [10 Hz - 2000 Hz]
Salt Spray Corrosion	>1000 hr

Cable fixation

Jacket cable outside diameter [mm]	2.00 - 16.60 mm
------------------------------------	-----------------

Drawings

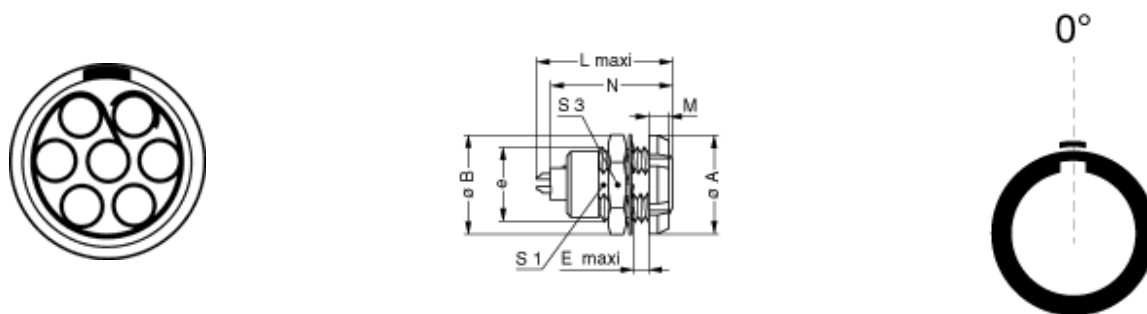

Dimensions

	B	A	E	L	M	N	S1	S3	e
mm.	25	24	9	30.7	4.5	28.1	16.5	22	M18x1.0
in.	0.98	0.94	0.35	1.21	0.18	1.11	0.65	0.87	

https://www.lemo.com/int_en/solutions/originals/b-indoor-keyed/ecg-3b-307-cll.html

LEMO products and services are provided "as is". LEMO makes no warranties or representations with regard to LEMO product & services or use of them, express, implied or statutory, including for accuracy, completeness, or security. The user is fully responsible for his products and applications using LEMO components.

Recommended By Lemo

Accessories















Compatible cap [BRE.3S.200.NAS](#)

Tools

Spanner 2 [DCM.65.200.AZ](#)

Spanner wrench [Socket for torque wrench DCM.65.200.AZ](#)

Cables

Cable PartNumber	Material	Colour	Cable image
CMN.07.T18.070PGZE		grey	
CMN.07.T18.070PNZE			
CMN.07.T20.062PGZE		grey	
CMN.07.T20.062PNZE			
CMN.07.T20.062QGZE	TPR (medical)	Grey	
CMN.07.T26.037QGZE	TPR (medical)	Grey	
CMN.07.T28.044PGZE		grey	
CMN.07.T28.044PNZE			
270250	PVC	Grey	
370500	PVC	Grey	
70140	PVC	Grey	
7041	PVC	Grey	
7050	PVC	Black	
717920	PVC	Grey	
CTR.75.030.121875G	PVC	Grey	

https://www.lemo.com/int_en/solutions/originals/b-indoor-keyed/ecg-3b-307-cll.html

LEMO products and services are provided "as is". LEMO makes no warranties or representations with regard to LEMO product & services or use of them, express, implied or statutory, including for accuracy, completeness, or security. The user is fully responsible for his products and applications using LEMO components.