



Image for illustrative purpose only

Summary

[Request a quote](#)

[Catalog](#)

Number of contacts Low Voltage	6
Wire Size/AWG	28 - 20
Gender	Standard
Socket / Receptacle	Socket / Receptacle - Fixed Panel Rear Mounted
Locking system	Push-pull
Jacket cable outside diameter [mm]	2.00 - 13.60 mm
Size	2B
Suggested matching part	FGG.2B.306.CLAD62Z
Series	B - Indoor keyed

https://www.lemo.com/int_en/solutions/originals/b-indoor-keyed/ecg-2b-306-cll.html

LEMO products and services are provided "as is". LEMO makes no warranties or representations with regard to LEMO product & services or use of them, express, implied or statutory, including for accuracy, completeness, or security. The user is fully responsible for his products and applications using LEMO components.

Technical details

Electrical Configuration

Contact Termination Low voltage	Solder
R (max)	3.6 mOhm
Insert configuration value	2B.306 - 6 Low Voltage
Insulator	L: PEEK (UL 94 / V-0/1.5)
Rated current	12 A
Vtest (contact-contact)	1350 V (AC), 1910 V (DC)
Vtest (contact-shell)	1450 V (AC), 2050 V (DC)
Contact Type	Solder
Max. Solid Conductor	0.5 mm ² (AWG 20)
Max. Stranded Conductor	0.5 mm ² (AWG 20)
Bucket Dia.	1 mm (0.039in)
Contact Dia.	1.3 mm (0.051in)
Number of contacts Low Voltage	6
Wire Size/AWG	28 - 20
Gender	Standard

Form & Material

Shell style / Model id	EC - Fixed receptacle with two nuts (back panel mounting)
Socket / Receptacle	Fixed Panel Rear Mounted
Housing material	Brass (chrome plated [SAE AMS 2460]) shell and collet nut, nickel plated [SAE AMS QQ N 290] brass latch sleeve and mid pieces
Locking system	Push-pull
Keying	G: 1 key (alpha=0, plug: male contacts, receptacle: female contacts)
Colour	Grey
Weight	17.42 g

https://www.lemo.com/int_en/solutions/originals/b-indoor-keyed/ecg-2b-306-cii.html

LEMO products and services are provided "as is". LEMO makes no warranties or representations with regard to LEMO product & services or use of them, express, implied or statutory, including for accuracy, completeness, or security. The user is fully responsible for his products and applications using LEMO components.

Environment

Technical domain	Audio Video, Energy and Industrial, Medical, Semiconductor, Specialties and Other, Test and Measurement, Transportation, Aerospace and UAV
Environmental sealing (IP rating)	IP50
Endurance	5000 mating cycles
Temperature range	-55°C / +250°C
Climatical Category	50/175/21
Humidity (max)	<=95% [at 60 deg C /140 F]
Shielding (min)	75 dB (10 MHz)
Shielding (min)	40 dB (1 GHz)
Shock Resistance	100 g [6 ms]
Vibration	15 g [10 Hz - 2000 Hz]
Salt Spray Corrosion	>1000 hr

Cable fixation

Jacket cable outside diameter [mm]	2.00 - 13.60 mm
------------------------------------	-----------------

Drawings

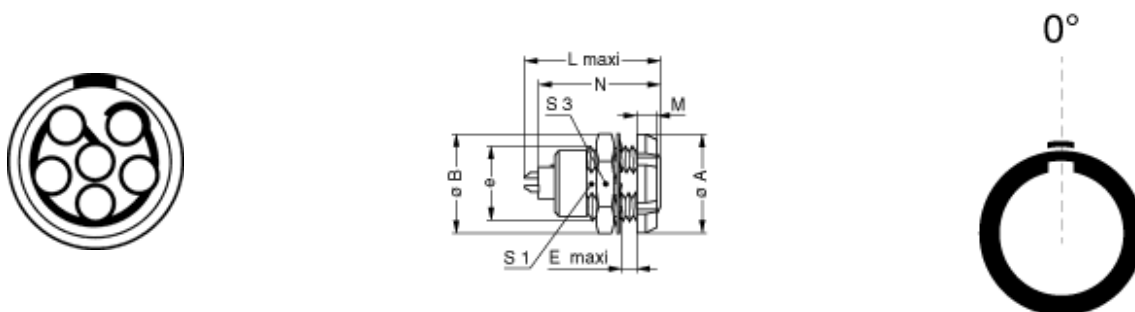

Dimensions

	B	A	L	M	N	S1	S3	E	e
mm.	19.2	20	26.7	3.5	24.6	13.5	17	6.5	M15x1.0
in.	0.76	0.79	1.05	0.14	0.97	0.53	0.67	0.26	

https://www.lemo.com/int_en/solutions/originals/b-indoor-keyed/ecg-2b-306-cll.html

LEMO products and services are provided "as is". LEMO makes no warranties or representations with regard to LEMO product & services or use of them, express, implied or statutory, including for accuracy, completeness, or security. The user is fully responsible for his products and applications using LEMO components.

Recommended By Lemo

Accessories

Compatible cap [BRE.2S.200.NAS](#)

Tools









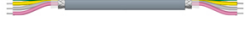

Spanner 2 [DCH.91.201.PA](#)

Spanner wrench [Socket for torque wrench DCM.65.170.AZ and DCM.2S.M15.6](#)

https://www.lemo.com/int_en/solutions/originals/b-indoor-keyed/ecg-2b-306-cll.html

LEMO products and services are provided "as is". LEMO makes no warranties or representations with regard to LEMO product & services or use of them, express, implied or statutory, including for accuracy, completeness, or security. The user is fully responsible for his products and applications using LEMO components.

Cables

Cable PartNumber	Material	Colour	Cable image
CMN.06.T20.062PGZE		grey	
CMN.06.T20.062PNZE			
CMN.06.T20.062QGZE	TPR (medical)	Grey	
CMN.06.T26.037QGZE	TPR (medical)	Grey	
CMN.06.T28.031PGCE	PVC	GREY	
CMN.06.T28.031PGZE		grey	
CMN.06.T28.031PNCE	PVC	Black	
CMN.06.T28.031PNZE			
CMN.06.T28.042QBCE	TPR (medical)		
CMN.06.T28.044PGZE		grey	
CMN.06.T28.044PNZE			
106220	PVC	Black	
106240	PTFE	White	
12080	PVC	Grey	
160140	PVC	Grey	
160240	PVC	Black	
160260	PVC	Black	
260250	PVC	Grey	
360500	PVC	Grey	
360750	PVC	Grey	
60260	PTFE	White	
6280	PVC	Black	

https://www.lemo.com/int_en/solutions/originals/b-indoor-keyed/ecg-2b-306-cll.html

LEMO products and services are provided "as is". LEMO makes no warranties or representations with regard to LEMO product & services or use of them, express, implied or statutory, including for accuracy, completeness, or security. The user is fully responsible for his products and applications using LEMO components.